

Schweres Hebel-Zylinderschloß

Heavy cylinder cam lock

Serrure à levier

Type 382

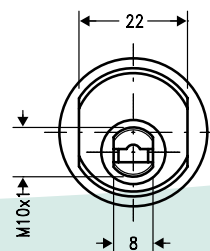
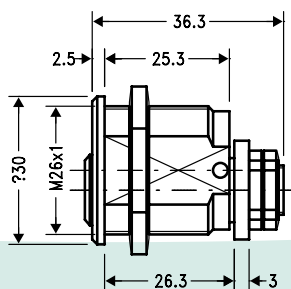
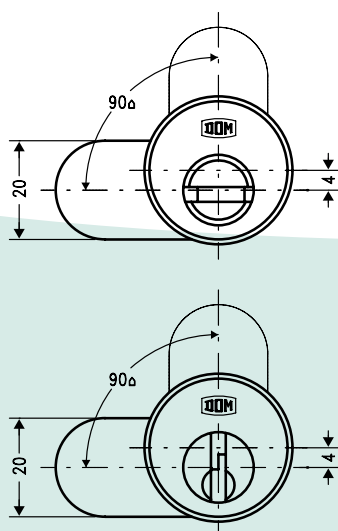

Technische Daten

Anwendungsbereich:	Briefkästen, Schlüsselschränke
Stiftzuhaltungen:	siehe Systembeschreibung
Abmessungen:	siehe Zeichnung
Schließweg:	90°
Material:	Zylinder: Messing
Färbung:	Zylinder: matt vernickelt; auf Wunsch Sonderfärbungen
Gewicht:	ca. 0,160 kg
Zubehör:	1 Mutter M26 2 Muttern M10 1 Schließhebel nach Bedarf
Funktion:	Normalausführung: Schlüssel nur in Sperrstellung abziehbar. Sonderausführung: Schlüssel zweimal abziehbar
Bitte beachten:	Bei Bestellung bitte stets den gewünschten Schließweg und gewünschte Hebelart angeben (siehe Seite 17)

Technical Data

range of application:	mailboxes, key cabinets
pin tumblers:	see system description
dimensions:	see drawing
key turn:	90°
material:	cylinder: brass
finish:	cylinder: dull nickel; special finish on request
weight:	approx. 0.160 kg
accessories:	1 nut M26 2 nuts M10 1 cam as required
function:	standard type: key can be withdrawn only in locked position special type: key can be withdrawn in two positions
please note:	When ordering please always state the required cam turn and the required type of cam according to the tables on page 17

Données Techniques

Domaine d'application:	boîtes aux lettres
Pistons:	voir description du système
Dimensions:	voir croquis
Tour de fermeture:	90°
Matière:	cylindre: laiton
Finition:	cylindre: nickelé mat, finitions spécifiques sur demande
Poids:	env. 0,160 kg
Accessoires:	1 écrou M26 2 écrous M10 1 pêne selon besoin
Fonctionnement:	Modèle standard: La clé ne peut être retirée qu'en position fermée Modèle spécial: La clé peut être retirée en deux positions
Attention:	Pour passer commande prière d'indiquer, en vous servant des tableaux de la page 17, le tour de fermeture et le pêne désirés

Lieferbare Schließhebel
(Sonderformen auf Anfrage)

available locking cams
(special forms on request)

Pênes disponibles
(formes spéciales sur demande)

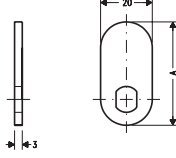
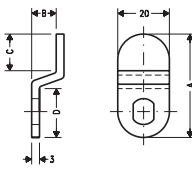
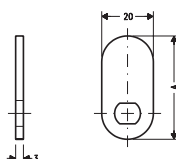
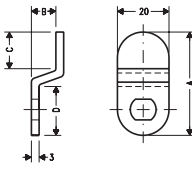
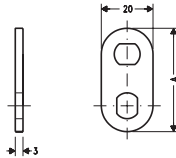
längsgelocht	longitudinal recess	trou longitudinal		<table border="1"> <thead> <tr> <th>Teile-Nr. Code No. No. de code</th> <th>A</th> <th>Teile-Nr. Code No. No. de code</th> <th>A</th> <th>Teile-Nr. Code No. No. de code</th> <th>A</th> </tr> </thead> <tbody> <tr><td>20.00.01</td><td>24</td><td>20.00.09</td><td>45</td><td>20.00.17</td><td>65</td></tr> <tr><td>20.00.02</td><td>30</td><td>20.00.12</td><td>48</td><td>20.00.19</td><td>70</td></tr> <tr><td>20.00.04</td><td>33</td><td>20.00.13</td><td>50</td><td>20.00.30</td><td>38</td></tr> <tr><td>20.00.05</td><td>35</td><td>20.00.14</td><td>52</td><td>24.21.12</td><td>100</td></tr> <tr><td>20.00.07</td><td>40</td><td>20.00.15</td><td>55</td><td></td><td></td></tr> <tr><td>20.00.08</td><td>43</td><td>20.00.16</td><td>60</td><td></td><td></td></tr> </tbody> </table>	Teile-Nr. Code No. No. de code	A	Teile-Nr. Code No. No. de code	A	Teile-Nr. Code No. No. de code	A	20.00.01	24	20.00.09	45	20.00.17	65	20.00.02	30	20.00.12	48	20.00.19	70	20.00.04	33	20.00.13	50	20.00.30	38	20.00.05	35	20.00.14	52	24.21.12	100	20.00.07	40	20.00.15	55			20.00.08	43	20.00.16	60																																																																																																																																																																																																								
Teile-Nr. Code No. No. de code	A	Teile-Nr. Code No. No. de code	A	Teile-Nr. Code No. No. de code	A																																																																																																																																																																																																																																															
20.00.01	24	20.00.09	45	20.00.17	65																																																																																																																																																																																																																																															
20.00.02	30	20.00.12	48	20.00.19	70																																																																																																																																																																																																																																															
20.00.04	33	20.00.13	50	20.00.30	38																																																																																																																																																																																																																																															
20.00.05	35	20.00.14	52	24.21.12	100																																																																																																																																																																																																																																															
20.00.07	40	20.00.15	55																																																																																																																																																																																																																																																	
20.00.08	43	20.00.16	60																																																																																																																																																																																																																																																	
längsgelocht, gekröpft	longitudinal recess, bent shape	trou longitudinal, pêne coudé		<table border="1"> <thead> <tr> <th>Teile-Nr. Code No. No. de code</th> <th>A</th> <th>B</th> <th>C</th> <th>D</th> <th>Teile-Nr. Code No. No. de code</th> <th>A</th> <th>B</th> <th>C</th> <th>D</th> </tr> </thead> <tbody> <tr><td>20.00.57</td><td>50</td><td>10,5</td><td>25</td><td>18</td><td>20.01.31</td><td>43</td><td>16</td><td>14</td><td>20</td></tr> <tr><td>20.00.59</td><td>52</td><td>10,5</td><td>20</td><td>25</td><td>20.01.36</td><td>45</td><td>8,5</td><td>15</td><td>24</td></tr> <tr><td>20.00.69</td><td>58</td><td>8,5</td><td>26</td><td>25</td><td>20.01.37</td><td>46</td><td>4,5</td><td>20</td><td>21</td></tr> <tr><td>20.00.70</td><td>59</td><td>3</td><td>30</td><td>24</td><td>20.01.38</td><td>46</td><td>6,5</td><td>18</td><td>20</td></tr> <tr><td>20.00.72</td><td>60</td><td>3</td><td>30</td><td>24</td><td>20.01.39</td><td>46</td><td>3,0</td><td>17</td><td>23</td></tr> <tr><td>20.00.78</td><td>67</td><td>5,5</td><td>37</td><td>25</td><td>20.01.41</td><td>48</td><td>11</td><td>23</td><td>19</td></tr> <tr><td>20.00.79</td><td>40</td><td>4,5</td><td>14</td><td>20</td><td>20.01.42</td><td>50</td><td>4</td><td>16</td><td>29</td></tr> <tr><td>20.00.80</td><td>52</td><td>4,5</td><td>28</td><td>19</td><td>20.01.43</td><td>50</td><td>10,5</td><td>20</td><td>23</td></tr> <tr><td>20.00.81</td><td>40</td><td>7,5</td><td>13</td><td>21</td><td>20.01.44</td><td>50</td><td>11,5</td><td>24</td><td>20</td></tr> <tr><td>20.01.12</td><td>35</td><td>5</td><td>7</td><td>23</td><td>20.01.45</td><td>50</td><td>20</td><td>18</td><td>29</td></tr> <tr><td>20.01.18</td><td>40</td><td>3</td><td>12</td><td>22</td><td>20.01.46</td><td>50</td><td>4,5</td><td>25</td><td>22</td></tr> <tr><td>20.01.19</td><td>40</td><td>3,5</td><td>11</td><td>23</td><td>20.01.47</td><td>43</td><td>11</td><td>14</td><td>23</td></tr> <tr><td>20.01.26</td><td>42</td><td>3</td><td>17</td><td>19</td><td>20.01.49</td><td>52</td><td>1,5</td><td>25</td><td>25</td></tr> <tr><td>20.00.54</td><td>68</td><td>4,5</td><td>40</td><td>24</td><td>20.01.57</td><td>53</td><td>6,5</td><td>19</td><td>25</td></tr> <tr><td>20.00.56</td><td>45</td><td>1,5</td><td>18</td><td>25</td><td>20.04.84</td><td>38</td><td>7,5</td><td>13</td><td>22</td></tr> <tr><td>20.00.66</td><td>55</td><td>15</td><td>14</td><td>38</td><td>20.91.37</td><td>48</td><td>3,5</td><td>16</td><td>27</td></tr> <tr><td>20.01.13</td><td>35</td><td>10,5</td><td>12</td><td>19</td><td>20.91.66</td><td>54</td><td>13</td><td>14</td><td>37</td></tr> <tr><td>20.01.17</td><td>40</td><td>2,5</td><td>10</td><td>28</td><td>22.34.00</td><td>35</td><td>3,5</td><td>9</td><td>22</td></tr> <tr><td>20.01.20</td><td>40</td><td>5,5</td><td>17</td><td>19</td><td>22.34.01</td><td>48</td><td>5,5</td><td>20</td><td>25</td></tr> <tr><td>20.01.25</td><td>42</td><td>1,5</td><td>15</td><td>25</td><td>23.43.73</td><td>45</td><td>13</td><td>19</td><td></td></tr> <tr><td>20.01.33</td><td>45</td><td>4,5</td><td>20</td><td>21</td><td>24.35.56</td><td>39</td><td>2</td><td>23,5</td><td></td></tr> <tr><td>20.01.29</td><td>43</td><td>4,5</td><td>18</td><td>19</td><td>24.41.74</td><td>37,5</td><td>8,5</td><td>24</td><td></td></tr> <tr><td>20.01.30</td><td>51</td><td>7</td><td>21</td><td>21</td><td></td><td></td><td></td><td></td><td></td></tr> </tbody> </table>	Teile-Nr. Code No. No. de code	A	B	C	D	Teile-Nr. Code No. No. de code	A	B	C	D	20.00.57	50	10,5	25	18	20.01.31	43	16	14	20	20.00.59	52	10,5	20	25	20.01.36	45	8,5	15	24	20.00.69	58	8,5	26	25	20.01.37	46	4,5	20	21	20.00.70	59	3	30	24	20.01.38	46	6,5	18	20	20.00.72	60	3	30	24	20.01.39	46	3,0	17	23	20.00.78	67	5,5	37	25	20.01.41	48	11	23	19	20.00.79	40	4,5	14	20	20.01.42	50	4	16	29	20.00.80	52	4,5	28	19	20.01.43	50	10,5	20	23	20.00.81	40	7,5	13	21	20.01.44	50	11,5	24	20	20.01.12	35	5	7	23	20.01.45	50	20	18	29	20.01.18	40	3	12	22	20.01.46	50	4,5	25	22	20.01.19	40	3,5	11	23	20.01.47	43	11	14	23	20.01.26	42	3	17	19	20.01.49	52	1,5	25	25	20.00.54	68	4,5	40	24	20.01.57	53	6,5	19	25	20.00.56	45	1,5	18	25	20.04.84	38	7,5	13	22	20.00.66	55	15	14	38	20.91.37	48	3,5	16	27	20.01.13	35	10,5	12	19	20.91.66	54	13	14	37	20.01.17	40	2,5	10	28	22.34.00	35	3,5	9	22	20.01.20	40	5,5	17	19	22.34.01	48	5,5	20	25	20.01.25	42	1,5	15	25	23.43.73	45	13	19		20.01.33	45	4,5	20	21	24.35.56	39	2	23,5		20.01.29	43	4,5	18	19	24.41.74	37,5	8,5	24		20.01.30	51	7	21	21					
Teile-Nr. Code No. No. de code	A	B	C	D	Teile-Nr. Code No. No. de code	A	B	C	D																																																																																																																																																																																																																																											
20.00.57	50	10,5	25	18	20.01.31	43	16	14	20																																																																																																																																																																																																																																											
20.00.59	52	10,5	20	25	20.01.36	45	8,5	15	24																																																																																																																																																																																																																																											
20.00.69	58	8,5	26	25	20.01.37	46	4,5	20	21																																																																																																																																																																																																																																											
20.00.70	59	3	30	24	20.01.38	46	6,5	18	20																																																																																																																																																																																																																																											
20.00.72	60	3	30	24	20.01.39	46	3,0	17	23																																																																																																																																																																																																																																											
20.00.78	67	5,5	37	25	20.01.41	48	11	23	19																																																																																																																																																																																																																																											
20.00.79	40	4,5	14	20	20.01.42	50	4	16	29																																																																																																																																																																																																																																											
20.00.80	52	4,5	28	19	20.01.43	50	10,5	20	23																																																																																																																																																																																																																																											
20.00.81	40	7,5	13	21	20.01.44	50	11,5	24	20																																																																																																																																																																																																																																											
20.01.12	35	5	7	23	20.01.45	50	20	18	29																																																																																																																																																																																																																																											
20.01.18	40	3	12	22	20.01.46	50	4,5	25	22																																																																																																																																																																																																																																											
20.01.19	40	3,5	11	23	20.01.47	43	11	14	23																																																																																																																																																																																																																																											
20.01.26	42	3	17	19	20.01.49	52	1,5	25	25																																																																																																																																																																																																																																											
20.00.54	68	4,5	40	24	20.01.57	53	6,5	19	25																																																																																																																																																																																																																																											
20.00.56	45	1,5	18	25	20.04.84	38	7,5	13	22																																																																																																																																																																																																																																											
20.00.66	55	15	14	38	20.91.37	48	3,5	16	27																																																																																																																																																																																																																																											
20.01.13	35	10,5	12	19	20.91.66	54	13	14	37																																																																																																																																																																																																																																											
20.01.17	40	2,5	10	28	22.34.00	35	3,5	9	22																																																																																																																																																																																																																																											
20.01.20	40	5,5	17	19	22.34.01	48	5,5	20	25																																																																																																																																																																																																																																											
20.01.25	42	1,5	15	25	23.43.73	45	13	19																																																																																																																																																																																																																																												
20.01.33	45	4,5	20	21	24.35.56	39	2	23,5																																																																																																																																																																																																																																												
20.01.29	43	4,5	18	19	24.41.74	37,5	8,5	24																																																																																																																																																																																																																																												
20.01.30	51	7	21	21																																																																																																																																																																																																																																																
quergelocht	transverse recess	trou transversal		<table border="1"> <thead> <tr> <th>Teile-Nr. Code No. No. de code</th> <th>A</th> <th>Teile-Nr. Code No. No. de code</th> <th>A</th> <th>Teile-Nr. Code No. No. de code</th> <th>A</th> </tr> </thead> <tbody> <tr><td>20.00.20</td><td>26</td><td>20.00.25</td><td>40</td><td>24.86.03</td><td>130</td></tr> <tr><td>20.00.21</td><td>30</td><td>20.00.26</td><td>43</td><td></td><td></td></tr> <tr><td>20.00.22</td><td>35</td><td>20.00.28</td><td>45</td><td></td><td></td></tr> <tr><td>20.00.24</td><td>38</td><td>20.00.34</td><td>58</td><td></td><td></td></tr> </tbody> </table>	Teile-Nr. Code No. No. de code	A	Teile-Nr. Code No. No. de code	A	Teile-Nr. Code No. No. de code	A	20.00.20	26	20.00.25	40	24.86.03	130	20.00.21	30	20.00.26	43			20.00.22	35	20.00.28	45			20.00.24	38	20.00.34	58																																																																																																																																																																																																																				
Teile-Nr. Code No. No. de code	A	Teile-Nr. Code No. No. de code	A	Teile-Nr. Code No. No. de code	A																																																																																																																																																																																																																																															
20.00.20	26	20.00.25	40	24.86.03	130																																																																																																																																																																																																																																															
20.00.21	30	20.00.26	43																																																																																																																																																																																																																																																	
20.00.22	35	20.00.28	45																																																																																																																																																																																																																																																	
20.00.24	38	20.00.34	58																																																																																																																																																																																																																																																	
quergelocht, gekröpft	transverse recess, bent shape	trou transversal, pêne coudé		<table border="1"> <thead> <tr> <th>Teile-Nr. Code No. No. de code</th> <th>A</th> <th>B</th> <th>C</th> <th>D</th> <th>Teile-Nr. Code No. No. de code</th> <th>A</th> <th>B</th> <th>C</th> <th>D</th> </tr> </thead> <tbody> <tr><td>20.00.55</td><td>52</td><td>4,5</td><td>25</td><td>19</td><td>20.01.49</td><td>52</td><td>1,5</td><td>25</td><td>25</td></tr> <tr><td>20.00.61</td><td>56</td><td>8,5</td><td>19</td><td>30</td><td>20.04.84</td><td>38</td><td>7,5</td><td>13</td><td>22</td></tr> <tr><td>20.00.84</td><td>46</td><td>4,5</td><td>20</td><td>21</td><td>20.91.66</td><td>54</td><td>13</td><td>14</td><td>37</td></tr> <tr><td>20.00.85</td><td>46</td><td>6</td><td>21</td><td>18</td><td>20.91.67</td><td>54</td><td>13</td><td>14</td><td>37</td></tr> <tr><td>20.00.93</td><td>48</td><td>6</td><td>25</td><td>21</td><td>20.31.61</td><td>54</td><td>10,5</td><td>23</td><td>25</td></tr> <tr><td>20.00.94</td><td>48</td><td>11</td><td>24</td><td>20</td><td>20.91.67</td><td>54</td><td>13</td><td>14</td><td>37</td></tr> <tr><td>20.00.96</td><td>52</td><td>1,5</td><td>23</td><td>27</td><td>23.63.78</td><td>44,5</td><td>10,5</td><td>12,5</td><td>25</td></tr> <tr><td>20.00.99</td><td>52</td><td>10,5</td><td>20</td><td>25</td><td>24.46.68</td><td>39</td><td>4,5</td><td>14</td><td>20</td></tr> <tr><td>20.01.46</td><td>50</td><td>4,5</td><td>25</td><td>22</td><td></td><td></td><td></td><td></td><td></td></tr> </tbody> </table>	Teile-Nr. Code No. No. de code	A	B	C	D	Teile-Nr. Code No. No. de code	A	B	C	D	20.00.55	52	4,5	25	19	20.01.49	52	1,5	25	25	20.00.61	56	8,5	19	30	20.04.84	38	7,5	13	22	20.00.84	46	4,5	20	21	20.91.66	54	13	14	37	20.00.85	46	6	21	18	20.91.67	54	13	14	37	20.00.93	48	6	25	21	20.31.61	54	10,5	23	25	20.00.94	48	11	24	20	20.91.67	54	13	14	37	20.00.96	52	1,5	23	27	23.63.78	44,5	10,5	12,5	25	20.00.99	52	10,5	20	25	24.46.68	39	4,5	14	20	20.01.46	50	4,5	25	22																																																																																																																																																	
Teile-Nr. Code No. No. de code	A	B	C	D	Teile-Nr. Code No. No. de code	A	B	C	D																																																																																																																																																																																																																																											
20.00.55	52	4,5	25	19	20.01.49	52	1,5	25	25																																																																																																																																																																																																																																											
20.00.61	56	8,5	19	30	20.04.84	38	7,5	13	22																																																																																																																																																																																																																																											
20.00.84	46	4,5	20	21	20.91.66	54	13	14	37																																																																																																																																																																																																																																											
20.00.85	46	6	21	18	20.91.67	54	13	14	37																																																																																																																																																																																																																																											
20.00.93	48	6	25	21	20.31.61	54	10,5	23	25																																																																																																																																																																																																																																											
20.00.94	48	11	24	20	20.91.67	54	13	14	37																																																																																																																																																																																																																																											
20.00.96	52	1,5	23	27	23.63.78	44,5	10,5	12,5	25																																																																																																																																																																																																																																											
20.00.99	52	10,5	20	25	24.46.68	39	4,5	14	20																																																																																																																																																																																																																																											
20.01.46	50	4,5	25	22																																																																																																																																																																																																																																																
längsgelocht und quergelocht	longitudinal recess and transverse recess	trou longitudinal et trou transversal		<table border="1"> <thead> <tr> <th>Teile-Nr. Code No. No. de code</th> <th>A</th> <th>Teile-Nr. Code No. No. de code</th> <th>A</th> <th>Teile-Nr. Code No. No. de code</th> <th>A</th> </tr> </thead> <tbody> <tr><td>20.00.05</td><td>35</td><td>20.00.12</td><td>48</td><td>20.00.42</td><td>47</td></tr> <tr><td>20.00.07</td><td>40</td><td>20.00.13</td><td>50</td><td>20.06.46</td><td>60</td></tr> <tr><td>20.00.08</td><td>43</td><td>20.00.15</td><td>55</td><td>22.26.23</td><td>70</td></tr> <tr><td>20.00.09</td><td>45</td><td>20.00.17</td><td>65</td><td></td><td></td></tr> </tbody> </table>	Teile-Nr. Code No. No. de code	A	Teile-Nr. Code No. No. de code	A	Teile-Nr. Code No. No. de code	A	20.00.05	35	20.00.12	48	20.00.42	47	20.00.07	40	20.00.13	50	20.06.46	60	20.00.08	43	20.00.15	55	22.26.23	70	20.00.09	45	20.00.17	65																																																																																																																																																																																																																				
Teile-Nr. Code No. No. de code	A	Teile-Nr. Code No. No. de code	A	Teile-Nr. Code No. No. de code	A																																																																																																																																																																																																																																															
20.00.05	35	20.00.12	48	20.00.42	47																																																																																																																																																																																																																																															
20.00.07	40	20.00.13	50	20.06.46	60																																																																																																																																																																																																																																															
20.00.08	43	20.00.15	55	22.26.23	70																																																																																																																																																																																																																																															
20.00.09	45	20.00.17	65																																																																																																																																																																																																																																																	